



SERVE-WELL ENTERPRISE CO., LTD.

台灣的老品牌，耐用耐操的代言者 LONG-GOOD 高壓吸送風機和透浦式鼓風機
30年專業製造經驗，為您解決尋找優質鼓風機的困擾
PROFESSIONAL MANUFACTURE OF
HIGH-PRESSURE BLOWER AND TURBO BLOWER



無油、無污染
NO Oil, No Pollution
低噪音
Low Noise
低震動
Low Vibration
高風壓
High Air Pressure
吸送風皆可
Dual Blow/Suction
高效率
High Efficiency
低耗能
Low Energy Loss
品質穩定
Steady Quality
壽命長，用者肯定
Life Span with
Customer's Satisfy

榮獲台灣
跨世紀
十大企業金鼎獎

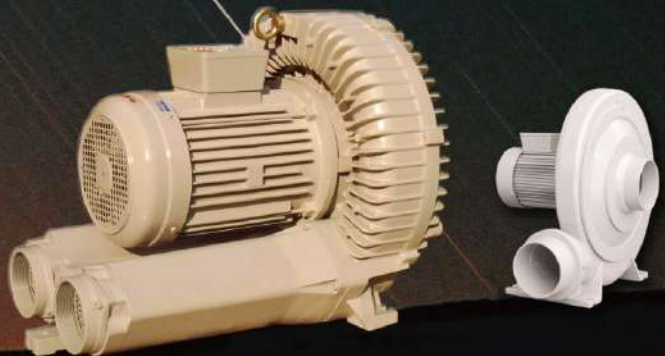

F 級絕緣馬達，高耐溫
鋁合金製造，機殼特厚
結構堅固，抗氧化，耐磨耐壓

洩壓閥 (風壓風量調節閥)

1. 釋放鼓風機多餘的壓力，使鼓風機能維持在安全電流內使用，以避兔馬達過載。

2. 安裝於鼓風機出入口之外接金屬管側，為吸吐兩用洩壓閥。

3. 整體為鋁合金製造，可耐至攝氏500度之高溫，堅固、耐用、美觀。 Pressure release valve (regulating valve for wind pressure and wind intensity)

1. Release the redundant pressure from the blower so as to keep the motor of the blower in operation within safe current limit, and avoid overload.

2. The pressure release valve which inhales and vents air is externally installed to one side of the metal pipe at the mouth of the blower.

3. The whole blower cabinet is made of aluminum alloy to resist a high temperature of 500°C. It is rigid, durable and nice-looking.

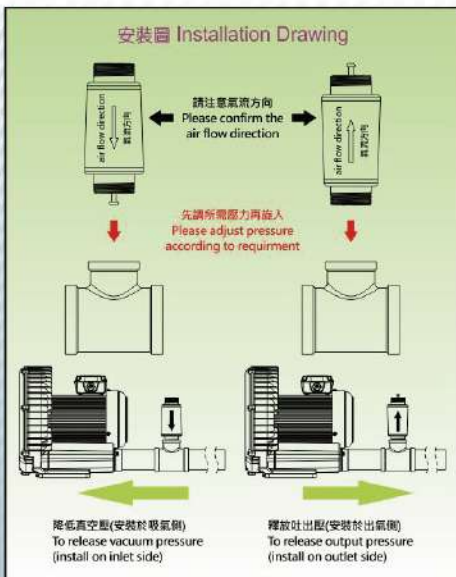

空氣過濾器

鼓風機入風口應加裝空氣過濾器以防止鼓風機吸到鐵絲、被布...等異物，這些異物在鼓風機運轉時有可能導致機身破裂、風扇斷裂、機體異常震動、馬達故障等現象發生。

Air Filter

The air inlet of the blower should be ased with an air filter to prevent the blower sucking screw, ragged cloth and useless objects. These useless objects inside the blower may result in crack with the blower cabinet, breakage with the vanes abnormal vibration while the blower is in operation.

型式 Model No.	口徑 Caliber (inch)	B (mm)	D (mm)	H (mm)	H1 (mm)	過濾精度 filter net density	概略重量 Approx. weight (kg)
MF-8	1	46	61	169	159	100目	0.24
MF-10	1-1/4	52	75	181	171		0.32
MF-12	1-1/2	60	85	195	186		0.4
MF-16	2	73	107	211	201		0.6
MF-20	2-1/2	90	148	275	247		1.55
MF-32	4	146	210	365	350		3.37

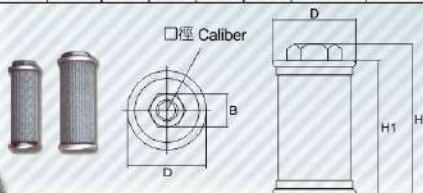

消音器

針對需要低噪音的客戶所設計。整體用金屬製作而成，消音器兩端皆有螺紋，可用旋轉固定於鐵管牙中，此裝置可用於鼓風機的出入口端或管線的末端，安裝方便，堅固耐高溫，且壽命長，最重要的是降低噪音的效率，請多加利用。

Silencer

It is specially designed for the customers who need low noises. The whole muffler is made of metal. The two ends of the silencer have threads which can screw in to match the applied to the mouth of the blower or the terminal of the pipe for easy installation. The silencer is rigid and high temperature resistance, and has a long service life. The most importance is to lower noises efficiently. Suggest you to make good use of it.

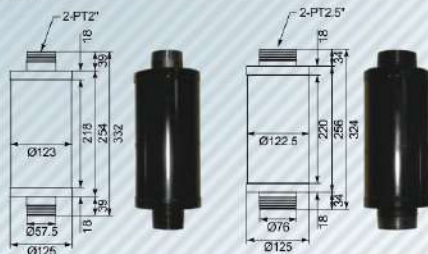

型號 TYPE	口徑 Orifice	適用機種 Suitable Models
ES-2	2"	LG-5068A, LG-5068, LG-6068, LG-7068
ES-2-1/2	2.5"	LG-8068, LG-9068



LG-006
 1/8HP



LG-106
 1/6HP



LG-2068
 1/2HP



LG-3068
 1HP



LG-5068
 2HP

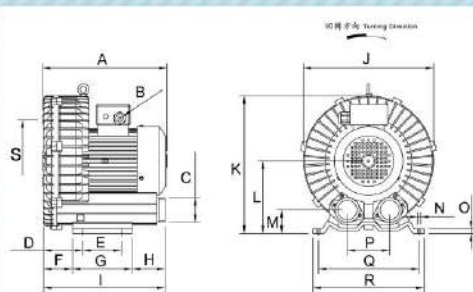

型號 TYPE	尺寸 Measurement (mm)						
	A	B	C	D	E	F	G
LG-006	162		Ø26	87		49	75
LG-106	218	Ø10	PT 1"	90			89
LG-2068	246	M16B	PT 1¼"	65	83	53	108
LG-3068	273	M16B	PT 1½"	100	95	79	138
LG-5068	326	M16B	PT 2"	72	115	58	157
型號 TYPE	尺寸 Measurement (mm)						
	H	I	J	K	L	M	N
LG-006	42	164	150	160	83	22	Ø7
LG-106	90	226	200	215	108	35	Ø9
LG-2068	87	250	242	262	132	44	Ø8
LG-3068	46	264	288	301	151	50	Ø10
LG-5068	98	313	333	342	178	58	Ø12
型號 TYPE	尺寸 Measurement (mm)						
	O	P	Q	R	S		
LG-006	11	62	127	144			
LG-106	10	73	165	192			
LG-2068	10	91	205	232			
LG-3068	7	115	225	257			
LG-5068	13	118	260	297	Ø200-3*120° M8		

如需確認尺寸，請洽業務部。
 If need confirm dimension, please contact with us.





LG-6068
 3HP



LG-7068
 5HP



LG-8068
 7-1/2HP



LG-9068
 10HP



LG-1506
 15HP

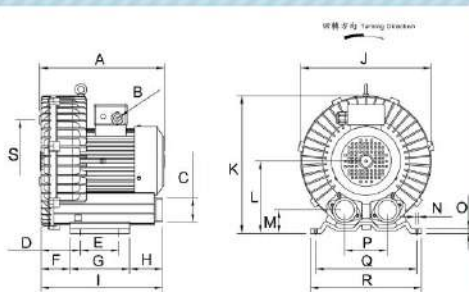

型號 TYPE	尺寸 Measurement (mm)						
	A	B	C	D	E	F	G
LG-6068	364	PG21	PT 2"	100	140	89	177
LG-7068	384	PG21	PT 2"	100	140	89	177
LG-8068	475	PG21	PT 2½"	30	280	14	315
LG-9068	475	PG21	PT 2½"	30	280	14	315
LG-1506	590	PG21	PT 4"	95	610		

型號 TYPE	尺寸 Measurement (mm)						
	H	I	J	K	L	M	N
LG-6068	93	354	384	390	202	60	Ø12
LG-7068	93	354	384	390	202	60	Ø12
LG-8068	162	490	463	500	271	82	Ø14
LG-9068	162	490	463	500	271	82	Ø14
LG-1506		730	552	570	290	95	

型號 TYPE	尺寸 Measurement (mm)				
	O	P	Q	R	S
LG-6068	13	121	290	326	Ø240-3*120° M8
LG-7068	13	121	290	326	Ø240-3*120° M8
LG-8068	32	143	365	417	Ø406-3*120° M12
LG-9068	32	143	365	417	Ø406-3*120° M12
LG-1506	30	212	360	407	

如需確認尺寸，請洽業務部。
 If need confirm dimension, please contact with us.

● 所有數據均為參考值，如需確認，請洽業務部。

相位	型號	額定出力 Max. power (KW)	額定電流 Rated current 220/380	最大吐出壓力 Max. blowing pressure (mmAq)	最大真空壓力 Max. Vacuum pressure (mmAq)	最大吐出風量 Max. blowing wind-force (m³/min)	噪音值 Noise Value (dB)	吸出口徑 In/Out Orifice (inch)	重量 weight (kg)	尺寸 (長×寬×高) Dimension L×W×H (mm)
Phase	Model									
三相 標準型 Three-Phase	50Hz IP54 200~230/380~400V									
	LG-006	0.06	0.4/0.3	230	170	0.3	52	26mm	4.5	164×150×160
	LG-106	0.09	0.5/0.3	500	475	0.75	52	1	7	226×200×215
	LG-2068	0.4	1.6/0.9	1100	1000	1.33	61	1-1/4	12	250×242×262
	LG-3068	0.8	3.5/1.9	2000	1500	2.4	68	1-1/2	17	273×286×300
	LG-5068	1.75	5.8/3.5	2900	2400	3.5	75	2	27	326×333×342
	LG-6068	2.2	8/5	3400	2500	6	75	2	35	364×384×390
	LG-7068	3.7	12/7	3400	2500	6.5	75	2	36	384×384×390
	LG-8068	5.5	20/11.5	3500	2750	9.5	76	2-1/2	76	490×463×500
	LG-9068	7.5	26/15	3500	2750	10	76	2-1/2	76	490×463×500
	LG-1506	11	37/21.5	3600	2700	14.2	82	4	123	730×552×575
	60Hz IP54 200~240/380~400V									
	LG-006	0.1	0.4/0.3	300	230	0.5	55	26mm	4.5	164×150×160
	LG-106	0.13	0.6/0.4	650	600	0.91	55	1	7	226×200×215
	LG-2068	0.5	1.8/1.0	1500	1300	1.55	63	1-1/4	12	250×242×262
	LG-3068	0.9	4.2/2.2	2800	2100	2.55	69	1-1/2	17	273×286×300
	LG-5068	1.9	7.0/4.0	4000	2800	3.9	78	2	27	326×333×342
	LG-6068	2.6	9/5.5	4350	3000	6.5	80	2	35	364×384×390
LG-7068	4	13/7.8	4350	3000	7	80	2	36	384×384×390	
LG-8068	6	25/15	4750	3550	11	86	2-1/2	76	490×463×500	
LG-9068	8	30/19	4750	3550	11.5	86	2-1/2	76	490×463×500	
LG-1506	12	38/22	4800	3550	17.1	87	4	123	730×552×575	
单相 標準型 Single-Phase	50Hz 110~115/200~230V									
	LG-006A	0.06	0.6/0.3	230	170	0.3	52	26mm	4.5	164×150×160
	LG-106A	0.09	1.3/0.7	500	490	0.75	52	1	7	226×200×215
	LG-2068A	0.4	4.0/2.0	1100	1000	1.33	61	1-1/4	12	250×242×262
	LG-3068A	0.8	10.5/4.8	1900	1400	2.4	68	1-1/2	17	273×286×300
	50Hz 200~230V									
	LG-5068A	1.75	10	2800	2300	4.2	75	2	27	326×333×342
	60Hz 110~115/200~240V									
	LG-006A	0.1	0.6/0.3	290	230	0.5	55	26mm	4.5	164×150×160
	LG-106A	0.13	1.9/1.2	650	650	0.9	55	1	7	226×200×215
	LG-2068A	0.5	5.8/2.8	1500	1300	1.55	63	1-1/4	12	250×242×262
	LG-3068A	0.9	12/6.0	2500	2000	2.65	69	1-1/2	17	273×286×300
	60Hz 200~240V									
	LG-5068A	1.9	10	3800	2400	4.6	78	2	27	326×333×342

- 訂貨時，請註明型號、電壓及週波數。
- 由於技術上的需要，本公司保留設計與變更的權利。
- 該風機使用時，最大電流值請勿超過額定電流，以維護該風機壽命。
- 請用英語，請註明型號、電壓及週波數。
- For using the blower, the maximum current value does not exceed the rated current so as to keep the blower long service life.
- Due to the technology requirement, we reserve the right to redesign and alter the products.
- Please indicate the voltage and frequency of the blower when place an order.

● 更多規格請來電洽詢。 All data are referred, please contact with us if need to confirm.

我們對質量的要求，遠高於數量 --- 4 --- 我們對服務的重視，遠高於業務



CX-1/4
0.18KW

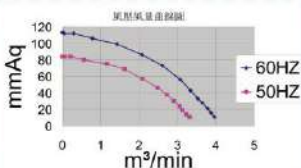

CX-1/2
0.4KW

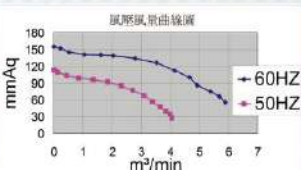

CX-1
0.75KW

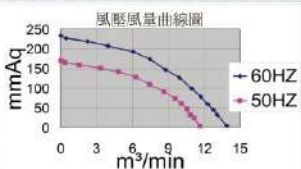

CX-2
1.5KW

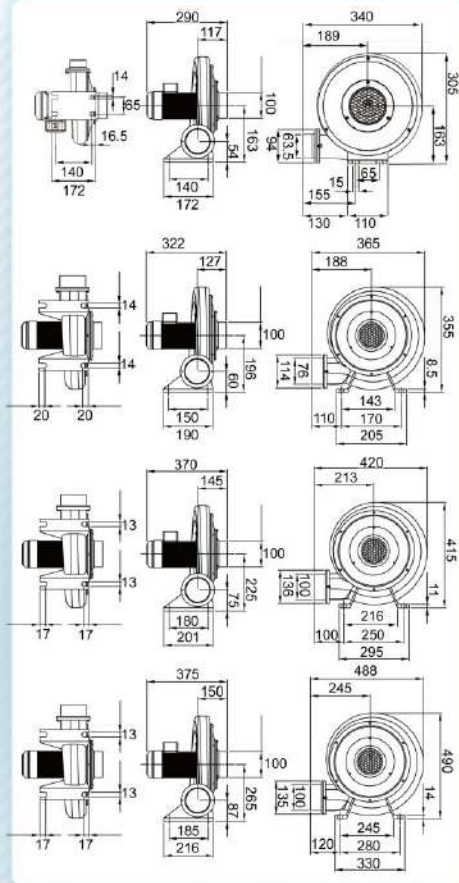
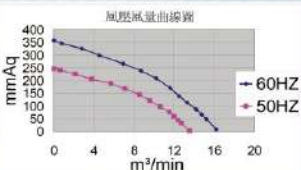

●由於技術上的需要我們保留設計尺寸變更的權利。訂購時請註明型號、電壓及週波數與吸風口是否要裝配風量調節盤。

型號 Type No.	功率 Power (KW)	電壓 Voltage (V)	週率 Frequency (Hz)	轉速 R.P.M.	噪音值 Noise value dB	額定電流 Rated current (A)	最大靜壓 Max. static pressure (mmAq)	最大風量 Max. blowing wing-force (m³/min)	概略重量 Approx. weight (kg)
CX-1/4	0.18	200~230	50	2800	50	2.0	84	3.3	11
			60	3500	62	1.5	113	3.9	
		380~415	50	2800	50	1.3	84	3.3	
			60	3500	62	0.9	113	3.9	
CX-1/2	0.4	200~230	50	2800	58	2.5	113	4.1	17
			60	3500	70	1.8	155	5.9	
		380~415	50	2800	58	1.5	113	4.1	
			60	3500	70	1.2	155	5.9	
CX-1	0.75	200~230	50	2800	64	3.3	170	11.6	22
			60	3500	80	2.8	234	13.9	
		380~415	50	2800	64	2.0	170	11.6	
			60	3500	80	1.6	234	13.9	
CX-2	1.5	200~230	50	2800	72	5.4	247	13.5	27
			60	3500	90	4.5	358	16.2	
		380~415	50	2800	72	3.1	247	13.5	
			60	3500	90	2.6	358	16.2	



CX-3
2.2KW

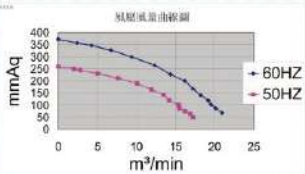

CX-5
3.7KW

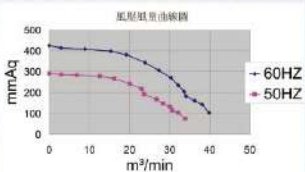

CX-7.5
5.5KW

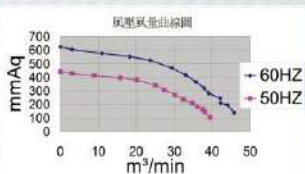

CX-10
7.5KW

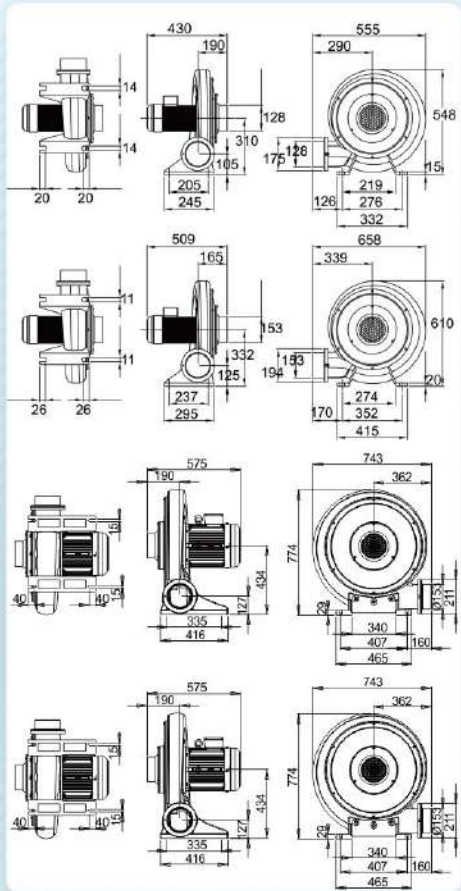
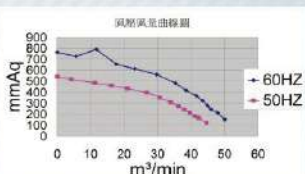

●由於技術上的需要我們保留設計與尺寸變更的權利。訂購時請註明型號、電壓及週波數與吸風口是否要裝配風量調節器。

型號 Type No.	功率 Power (KW)	電壓 Voltage (V)	週率 Frequency (Hz)	轉速 R.P.M.	噪音值 Noise value dB	額定電流 Rated current (A)	最大靜壓 Max. static pressure (mmAq)	最大風量 Max. blowing wing-force (m³/min)	概略重量 Approx. weight (kg)
CX-3	2.2	200~230	50	2800	76	8	259	17.2	35
		380~415	60	3500	95	7	372	20.9	
		200~230	50	2800	76	4.6	259	17.2	
CX-5	3.7	380~415	60	3500	95	4.0	372	20.9	47.5
		200~230	50	2800	80	13	291	33.9	
		380~415	60	3500	100	12	426	39.8	
CX-7.5	5.5	380~415	50	2800	84	20	441	39.5	95.8
		200~230	60	3500	105	19	621	45.7	
		380~415	60	3500	105	11	621	45.7	
CX-10	7.5	200~230	50	2800	86	26	534	39.0	96.8
		380~415	60	3500	108	25	742	45.9	
		200~230	50	2800	86	15	534	39.0	
380~415	60	3500	108	14	742	45.9			





LONG-GOOD

**SERVE-WELL
ENTERPRISE CO., LTD.**

升圓企業有限公司 SERVE-WELL ENTERPRISE CO., LTD.

TEL: +886-4-25228046 FAX: +886-4-25248251

Http://www.serve-well.com

E-mail: sales@serve-well.com

serve.well@msa.hinet.net

